

**LA1837**

Single-Chip Home Stereo IC with Electronic Tuning Support

Overview

The LA1837 is a single-chip AM/FM IF and MPX IC that supports electronic tuning and was developed for use in home stereo systems. It is optimal for use in automatic station selection systems that use the SD and IF counting techniques.

Functions

AM: RF amplifier, mixer, oscillator, IF amplifier, detector AGC, oscillator buffer, S-meter, narrow-band SD, IF buffer

FM IF: IF amplifier, quadrature detector, S-meter, S-curve detector, IF buffer output

MPX: PLL stereo decoder, stereo display, forced mono, VCO stop, post amplifier, audio muting, adjacent channel interference rejection function

Features

- On-chip MPX VCO (no external components required)
- Adjacent channel interference rejection function (third and fifth order)
- Supports both the SD and the IF counting techniques.
- The AM and FM SD sensitivities can be set independently.
- The AM and FM output levels can be set independently.
- Improved AM practical sensitivity and high-input distortion characteristics

Package Dimensions

unit: mm

3061-DIP30S

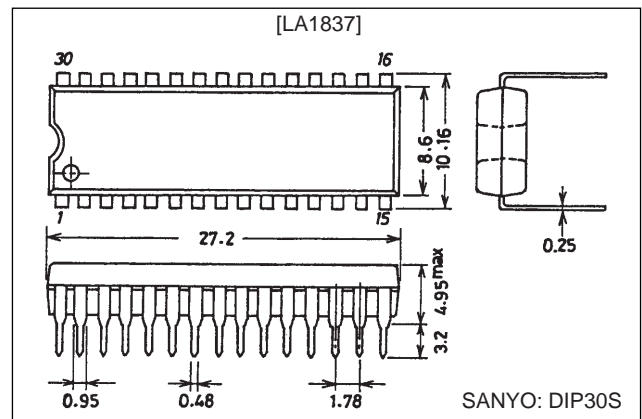

Specifications

Maximum Ratings at $T_a = 25^\circ\text{C}$

Parameter	Symbol	Conditions	Ratings	Unit
Maximum supply voltage	$V_{CC \text{ max}}$		12	V
Allowable power dissipation	$P_d \text{ max}$	$T_a \leq 70^\circ\text{C}$	550	mW
Operating temperature	T_{opr}		-20 to +70	$^\circ\text{C}$
Storage temperature	T_{stg}		-40 to +125	$^\circ\text{C}$

Operating Conditions at $T_a = 25^\circ\text{C}$

Parameter	Symbol	Conditions	Ratings	Unit
Recommended supply voltage	V_{CC}		9	V
Operating voltage range	$V_{CC \text{ op}}$		7 to 11	V

SANYO Electric Co., Ltd. Semiconductor Business Headquarters

TOKYO OFFICE Tokyo Bldg., 1-10, 1 Chome, Ueno, Taito-ku, TOKYO, 110 JAPAN

LA1837

Electrical Characteristics at $T_a = 25^\circ\text{C}$, $V_{CC} = 9\text{ V}$, in the specified Test Circuit

Parameter	Symbol	Conditions	Ratings			Unit
			min	typ	max	
[FM Mono Characteristics] $f_c = 10.7\text{ MHz}$, $f_m = 1\text{ kHz}$, with the coil adjusted so that $V_{AFC} - V_{REG} = 0\text{ V}$						
Current drain	I_{CCO-FM}	With no input	18	31	44	mA
Demodulation output	V_{OFM}	100 dB μ , 100% mod. The pin 16 output	730	1100	1460	mVrms
Channel balance	C.B-mono	100 dB μ , 100% mod. The pin 16 output/pin 17 output	-1.5	0	+1.5	dB
Total harmonic distortion (mono)	$THD_{FM(1)}$	100 dB μ , 100% mod. The pin 16 output		0.3	1.3	%
Total harmonic distortion (mono)	$THD_{FM(2)}$	100 dB μ , 200% mod. The pin 16 output		1.0	5	%
Signal-to-noise ratio	S/N_{FM}	100 dB μ , 100% mod. The pin 16 output	72	80		dB
AM rejection ratio	AMR	100 dB μ , AM 30 % mod. The pin 16 output	45	65		dB
Limiting input voltage	-3 dBLS.	100 dB μ , 100% mod. Referenced to the output. The input such that the output is down -3 dB.	26	32	38	dB μ
LED sensitivity	SD_{On-FM}		51	60	69	dB μ
LED bandwidth	SD_{BW}	100 dB μ	85	120	170	kHz
IF count buffer output	$V_{IFBuff-FM}$	100 dB μ . The pin 13 output	80	120	160	mVrms
S-meter output	$V_{SM-FM(1)}$	0 dB μ . The pin 11 output	0	0.1	0.5	V
	$V_{SM-FM(2)}$	100 dB μ . The pin 11 output	3.6	4.3	5.0	V
Muting attenuation	Mute-Att	100 dB μ , 100% mod. The pin 16 output	75	85		dB
[FM Stereo Characteristics] $f_c = 10.7\text{ MHz}$, 100 dB μ , $f_m = 1\text{ kHz}$, $L + R = 90\%$, Pilot = 10%						
Separation (left)	Sep_L	L mod. The pin 16 output/pin 17 output	30	45		dB
Separation (right)	Sep_R	R mod. The pin 17 output/pin 16 output	30	45		dB
Stereo on level	ST_{ON}	The pilot modulation such that V7 is under 0.7 V.	1.3	2.7	5	%
Stereo off level	ST_{OFF}	The pilot modulation such that V7 is over 4.5 V.		1.5		%
Total harmonic distortion (main)	THD_{-main}	L+R mod. The pin 16 output		0.3	1.3	%
Adjacent channel interference rejection ratio	Brej-3rd	$f_s = 113\text{ kHz}$, $V_s = 90\%$, Pilot = 10 %, The pin 16 output vs. the L-R mod. 1 kHz demodulated output		40		dB
	Brej-5th	$f_s = 189\text{ kHz}$, $V_s = 90\%$, Pilot = 10 %, The pin 16 output vs. the L-R mod. 1 kHz demodulated output		40		dB
[AM Characteristics] $f_c = 1000\text{ kHz}$, $f_m = 1\text{ kHz}$						
Current drain	I_{CCO-AM}	With no input	15	25	35	mA
Detector output	$V_{OAM(1)}$	23 dB μ , 30% mod. The pin 16 output	100	180	360	mVrms
	$V_{OAM(2)}$	80 dB μ , 30% mod. The pin 16 output	200	320	500	mVrms
Signal-to-noise ratio	$S/N_{AM(1)}$	23 dB μ , 30% mod. The pin 16 output	18	22		dB
	$S/N_{AM(2)}$	80 dB μ , 30% mod. The pin 16 output	49	55		dB
Total harmonic distortion (mono)	$THD_{AM(1)}$	80 dB μ , 30% mod. The pin 16 output		0.4	1.2	%
	$THD_{AM(2)}$	80 dB μ , 80% mod. The pin 16 output		1.0	4.0	%
LED sensitivity	SD_{On-AM}		17	27	37	dB μ
Local oscillator buffer output	V_{OSC-AM}	With no input. The pin 30 output	110	160	220	mVrms
IF counter buffer output	$V_{IFBuff-AM}$	80 dB μ , no modulation. The pin 13 output	160	220	300	mVrms
ST-IF output	$V_{STIF-AM}$	80 dB μ , no modulation. The pin 7 output	16	34	48	mVrms
S-meter output	V_{SM-AM}	0 dB μ , no modulation.	0	0	0.2	V

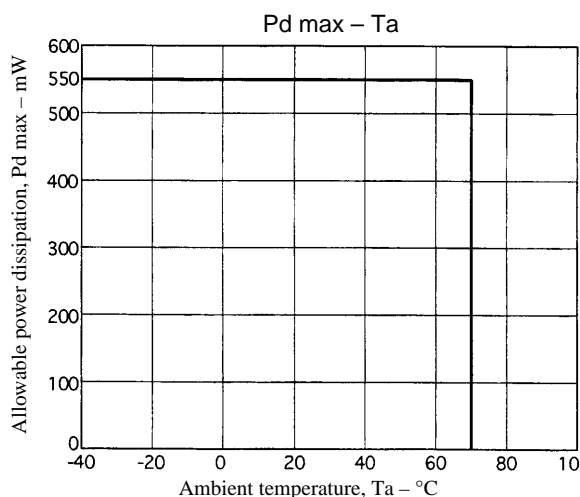

LA1837

Block Diagram

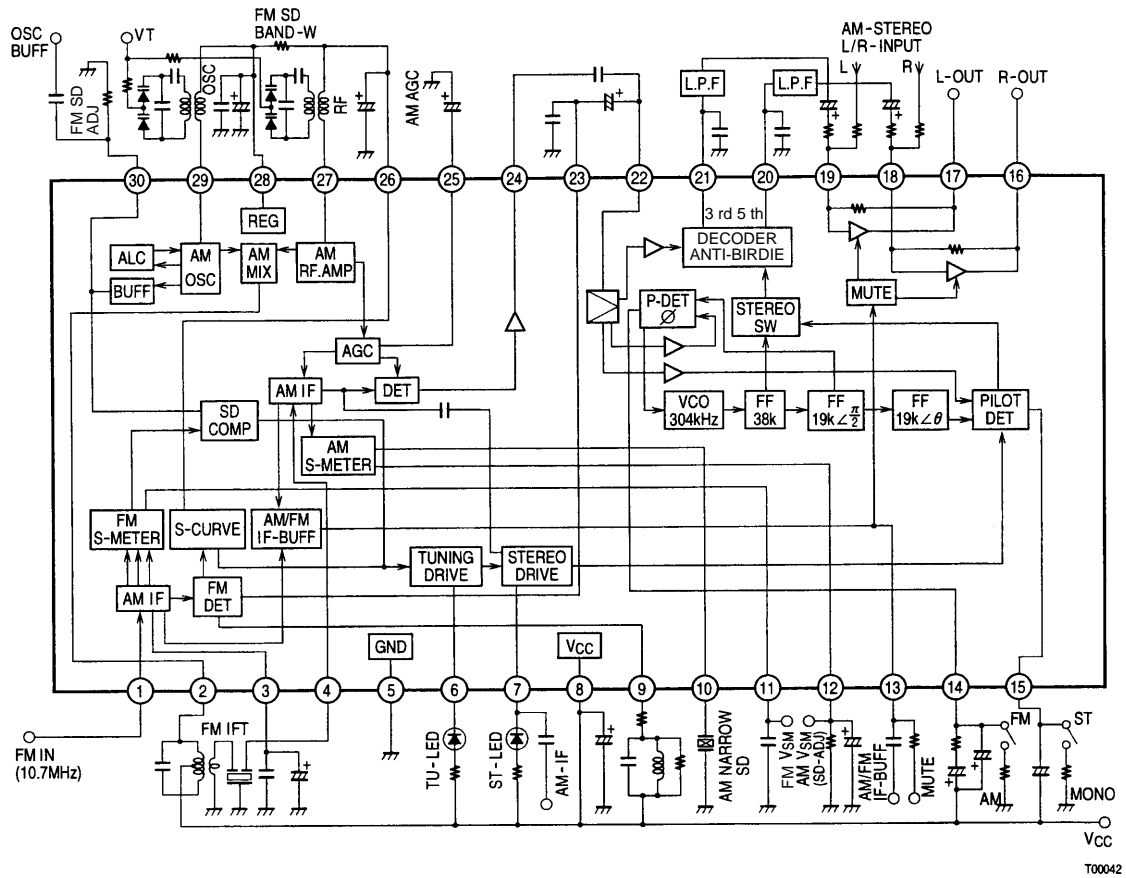

Test Circuit Diagram

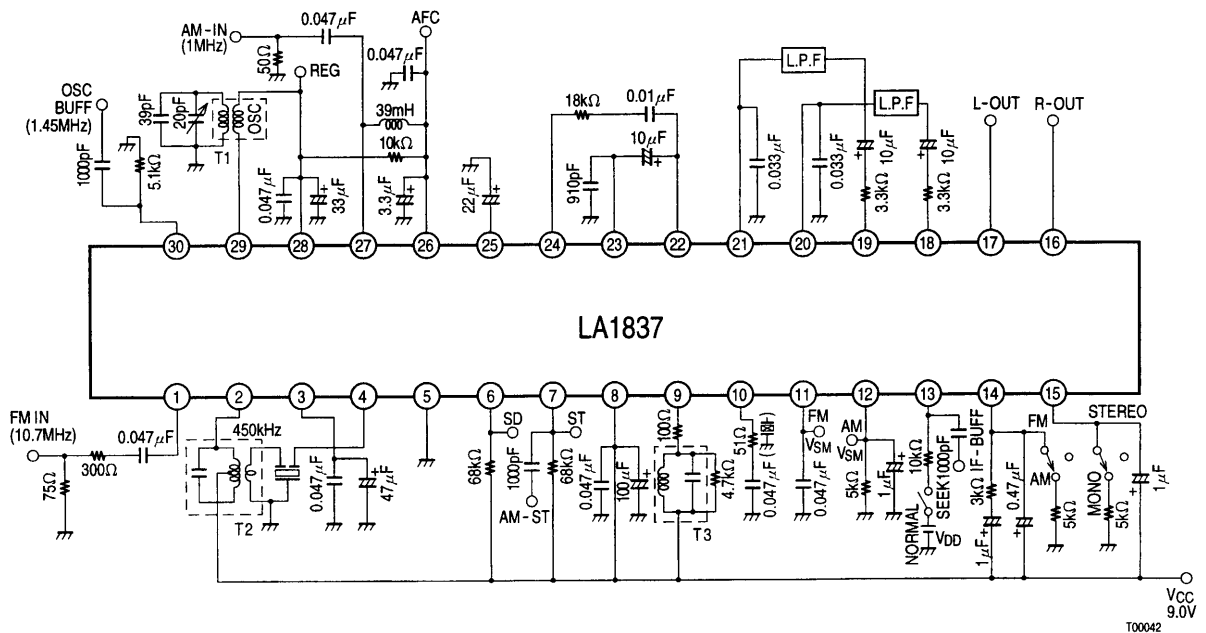

Coil Specifications

· AM oscillator (for the DUT)
HW-50425 (Mitsumi Electric Co., Ltd.)

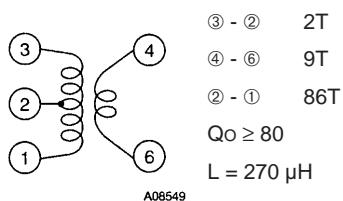

· IFT
YD-1073-1 (Mitsumi Electric Co., Ltd.)

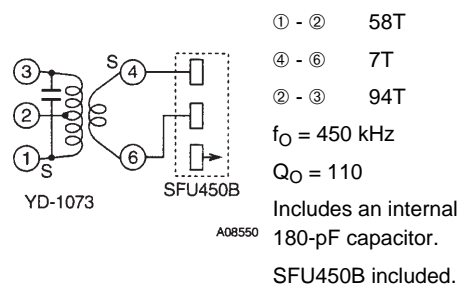

· FM detector
600BEAS-9715Z (The Toko Electric Corporation)

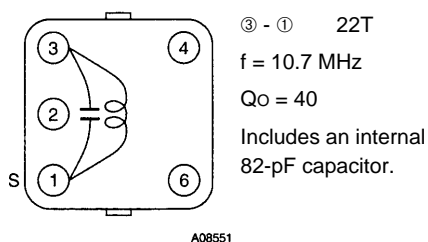

Pin Functions

Pin No.	Pin function	Pin voltage (V)	Pin description	Equivalent circuit
1	FM IF input	Vreg	Input impedance $r_i = 330 \Omega$	 A08552
2	AM mixer output	VCC	Connect the mixer coil between this pin and VCC.	 A08553
3	FM IF input bypass	Vreg	Also functions as the MPX regulator filter.	See pin 1.
4	AM IF input	Vreg	Input impedance $r_i = 2 \text{ k}\Omega$	 A08554
5	GND	0 V		
6 7	TU - LED ST - LED AM-IF output	VCC VCC	Active low Open collector output AM stereo IF output (pin 7) The current input must not exceed 150 μA .	 A08555
8	VCC	VCC		
9	FM detector	VCC	Recommended detector coil: 600BEAS-9715Z (The Toko Electric Corporation)	 A08556

Continued on next page.

LA1837

Continued from preceding page.

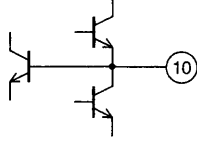
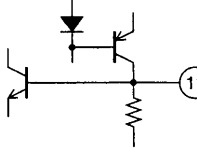
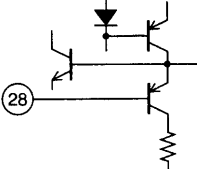
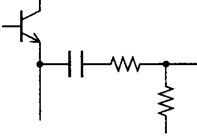
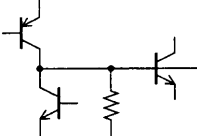
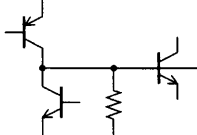
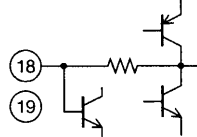
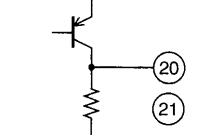
Pin No.	Pin Function	Pin voltage (V)	Pin description	Equivalent circuit
10	AM narrow band CF connection	1.3 V	Recommended narrow band CF: BFU450 C4N (Murata Mfg. Co., Ltd.) If the narrow band SD is not used, bypass this circuit with a 50-Ω resistor and a 0.047-μF capacitor connected in series.	 A08557
11	FM S-meter output	0 V	$R_L = 8\text{ k}\Omega$	 A08558
12	AM S-meter output AM SD sensitivity adjustment	0 V (AM)	The AM SD sensitivity is adjusted with the value of the external resistor connected between this pin and ground.	 A08559
13	AM and FM IF buffer output, output control switch (mute switch)	0 V	$V_{13} \leq 0.5\text{ V}$: Reception state $1.4\text{ V} \leq V_{13} \leq 2.2\text{ V}$: IF buffer output turned on $V_{13} \geq 3.5\text{ V}$: IF buffer output and muting are turned on	 A08560
14	Phase comparator low-pass filter (FM/AM switching)	$V_{CC} - 1.4$ (FM) 0 V (AM)	Connecting this pin to ground through a resistor sets the IC to AM mode. Resistor value limits: 2.7 kΩ (when $V_{CC} = 7\text{ V}$) 3.9 kΩ (8 V) 5.1 kΩ (9 V) 6.2 kΩ (10 V) 7.5 kΩ (11 V)	 A08561
15	Pilot detector low-pass filter (forced mono) (VCO stop)	$V_{CC} - 1.0$	If a current of 50 μA or greater flows from this pin, the system is forced to mono. Connecting this pin to ground stops the VCO. The resistor limit values are the same as for pin 14.	 A08562
16 17 18 19	Post amplifier input and output	V_{reg} V_{reg}	Output impedance $r_o = 200\ \Omega$ Pin 16: right output, pin 17: left output Inverting inputs Pin 18: right input, pin 19: left input $R_{NF} = 33\text{ k}\Omega$	 A08563
20 21	MPX output	3.5 V 3.5 V	Output impedance $r_o = 3.3\text{ k}\Omega$ Pin 20: right de-emphasis Pin 21: left de-emphasis	 A08564

Continued on next page.

LA1837

Continued from preceding page.

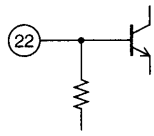
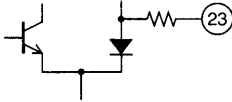
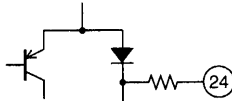
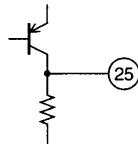
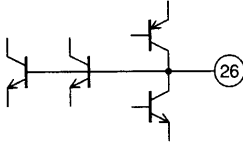
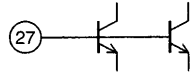
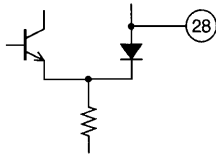
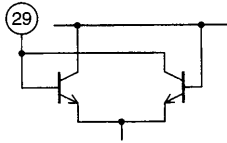
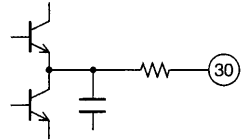
Pin No.	Pin Function	Pin voltage (V)	Pin description	Equivalent circuit
22	MPX input	2.9 V	Input impedance $r_i = 20 \text{ k}\Omega$	 <p style="text-align: right;">A08565</p>
23	FM demodulator output	2.8 V (FM) 2.8 V (AM)	Output impedance $r_o = 3.0 \text{ k}\Omega$ The separation can be modified by inserting a capacitor between this pin and ground. Set $V_O \text{ sub}/V_O \text{ main}$ to be about 0 dB.	 <p style="text-align: right;">A08566</p>
24	AM detector output	0 V (FM) 0.5 V (AM)	Output impedance $r_o = 3.3 \text{ k}\Omega$ The AM frequency characteristics can be modified by adjusting the time constants of the circuits between this pin and pin 22, and between this pin and ground.	 <p style="text-align: right;">A08567</p>
25	AM AGC	0 V (FM) 0.5 V (AM)	The built-in load resistor $R = 11 \text{ k}\Omega$.	 <p style="text-align: right;">A08568</p>
26	AFC	Vreg	The FM SD bandwidth can be modified with the external resistor connected between this pin and pin 28.	 <p style="text-align: right;">A08569</p>
27	AM RF input	Vreg	Use this pin at the same potential as pin 28.	 <p style="text-align: right;">A08570</p>
28	REG	Vreg	Vreg = 3.6 V	 <p style="text-align: right;">A08571</p>
29	OSC	Vreg	Use an oscillator coil between this pin and pin 28.	 <p style="text-align: right;">A08572</p>
30	Oscillator buffer output, FM SD sensitivity adjustment	1.6 V (FM) 1.3 V (AM)	The FM SD sensitivity can be modified with the external resistor connected between this pin and ground. Output impedance $r_o = 20 \Omega$	 <p style="text-align: right;">A08573</p>

Overall FM Characteristics

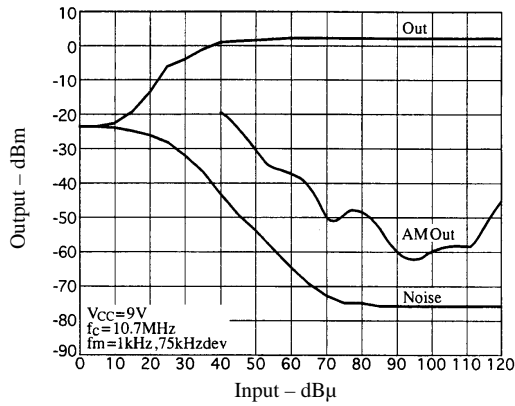

FM THD/ V_{SM} Characteristics

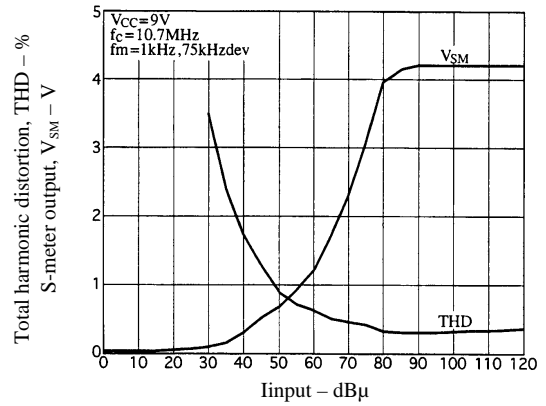

FM THD Band Characteristics

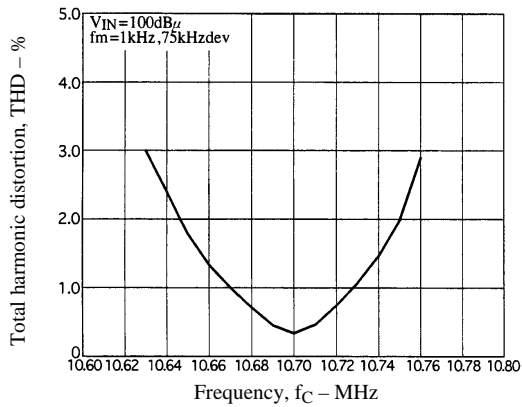

Distortion vs. Frequency Characteristics

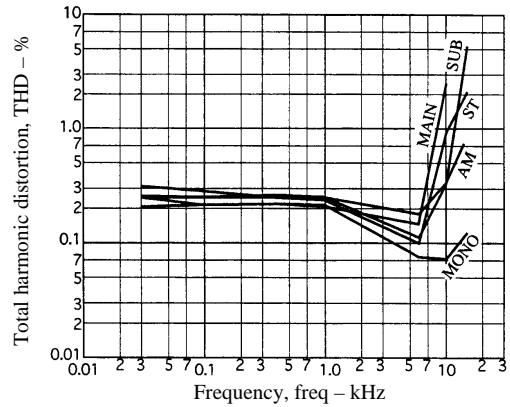

Separation vs. Frequency Characteristics

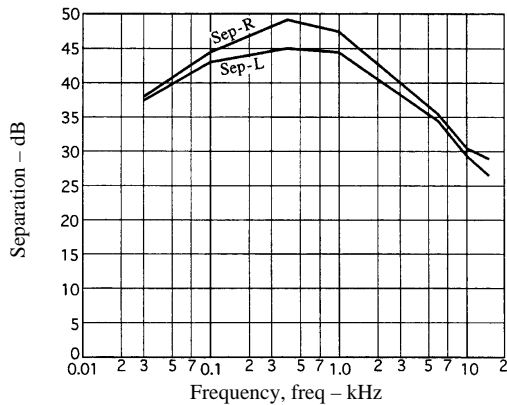

Adjacent Channel Interference Rejection Ratio

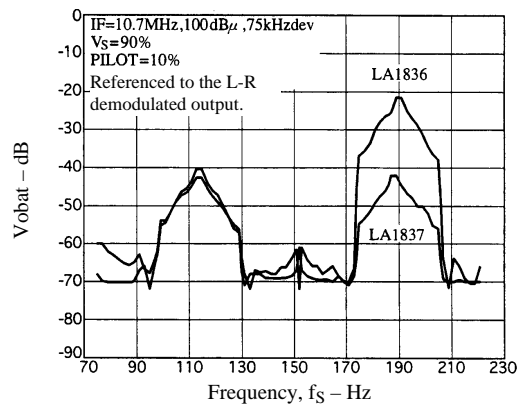

Capture Range Characteristics

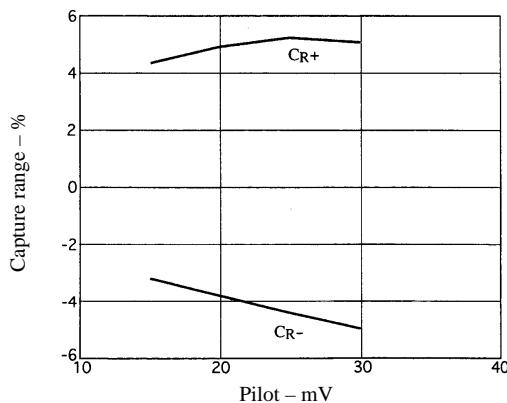

SD Sensitivity Adjustment Characteristics

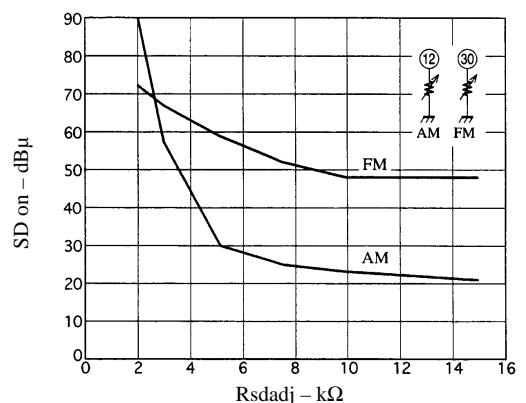

SD Sensitivity Adjustment Characteristics

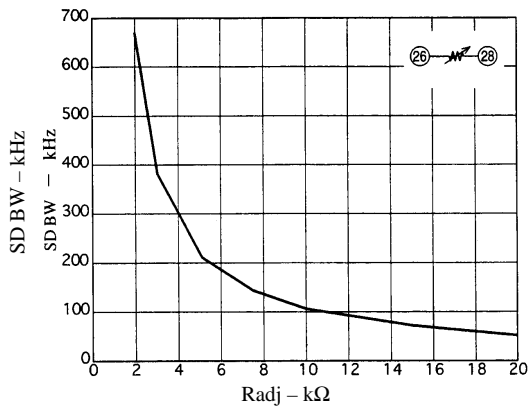

Overall AM Characteristics

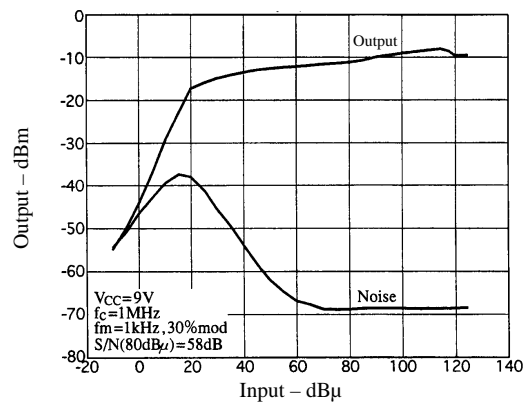

AM THD/V_{SM} Characteristics

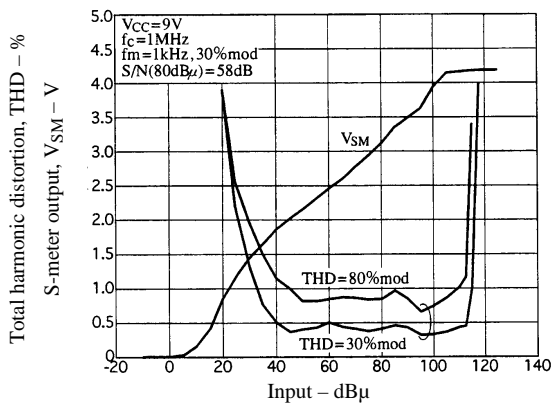

AM Detector Output Frequency Characteristics (1)

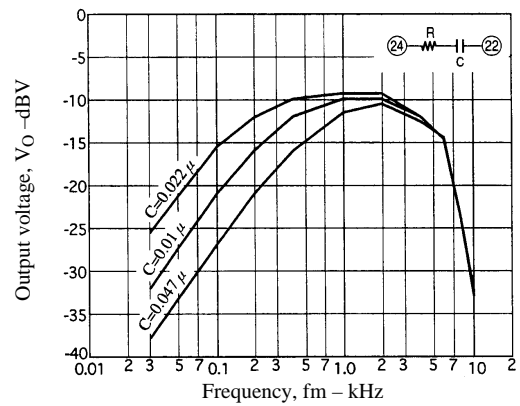

AM Detector Output Frequency Characteristics (2)

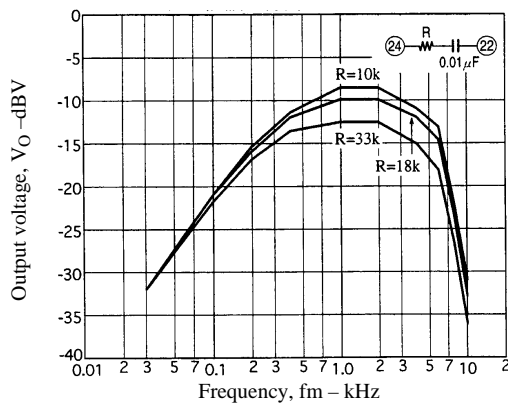

Distortion vs. Ambient Temperature Characteristics

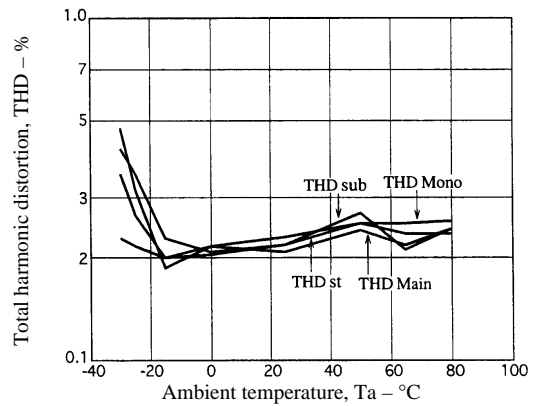

Separation vs. Ambient Temperature Characteristics

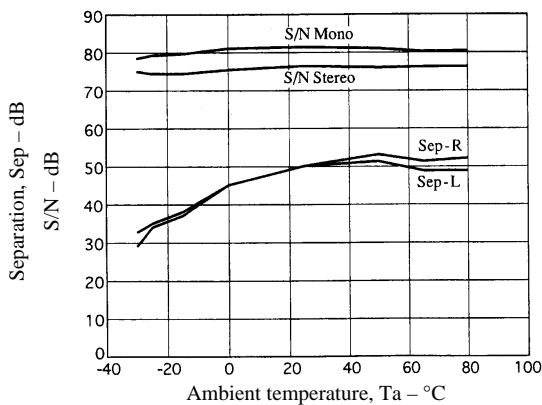

- No products described or contained herein are intended for use in surgical implants, life-support systems, aerospace equipment, nuclear power control systems, vehicles, disaster/crime-prevention equipment and the like, the failure of which may directly or indirectly cause injury, death or property loss.
- Anyone purchasing any products described or contained herein for an above-mentioned use shall:
 - ① Accept full responsibility and indemnify and defend SANYO ELECTRIC CO., LTD., its affiliates, subsidiaries and distributors and all their officers and employees, jointly and severally, against any and all claims and litigation and all damages, cost and expenses associated with such use:
 - ② Not impose any responsibility for any fault or negligence which may be cited in any such claim or litigation on SANYO ELECTRIC CO., LTD., its affiliates, subsidiaries and distributors or any of their officers and employees jointly or severally.
- Information (including circuit diagrams and circuit parameters) herein is for example only; it is not guaranteed for volume production. SANYO believes information herein is accurate and reliable, but no guarantees are made or implied regarding its use or any infringements of intellectual property rights or other rights of third parties.

This catalog provides information as of August, 1997. Specifications and information herein are subject to change without notice.